



Kit LIBRA

Garage door opener



CONTENTS

A) Components	p.1
B) Technical data and main features	p.2
C) Safety tips and preliminary checks	p.4
D) Rail assembly	p.5
E) Programming	p.8
F) Radio transmitter coding	p.13
G) Electrical wiring diagram	p.14
Photocell wiring	p.15
Manual release	p.16
Adapter for overhead doors	p.18
Maintenance	p.19
Trouble shooting	p.20
Certificate of compliance	p.21
Disposal	p.22















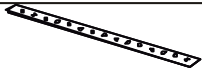



KEEP THIS MANUAL IN A SAFE PLACE

- Do not allow children to play with the automated garage door.
- Watch out the door operation and keep the area clear until the door is completely opened or closed.
- Check the automation operation regularly, in particular, check that cables, springs and fixing brackets do not show signs of wear, damage or unbalance.
- Do not use the automation if repairing or maintenance is needed. Incorrect assembly or improper use may cause serious injury!

A. COMPONENTS

The kit includes door opener, rail and fittings as shown below:

	Description	Quantity
	Door opener	1
	User's manual	1
	Transmitter	1
	Bent door arm	1
	Mounting bracket	2
	Support bracket	1
	Rail mounting bracket	3
	Front wall fixing bracket	1
	Door fixing bracket	1
	Hex-head tapping screw 6x15	8
	Hex-head nut and screw 6x80	1
	Pin 8x25	1
	Split pin 3x20	1
	Cogwheel	1
	Screw anchor 6x80	6
	Hex-head nut and screw 8x20	4

Rail

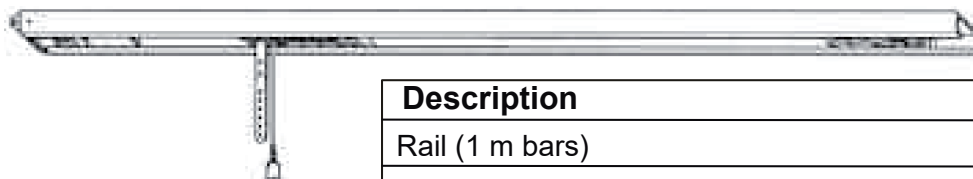

Description	Quantity
Rail (1 m bars)	3
Door mounting bracket	1
Chain	1
Manual release string	1
Trolley	1

B. TECHNICAL DATA AND MAIN FEATURES

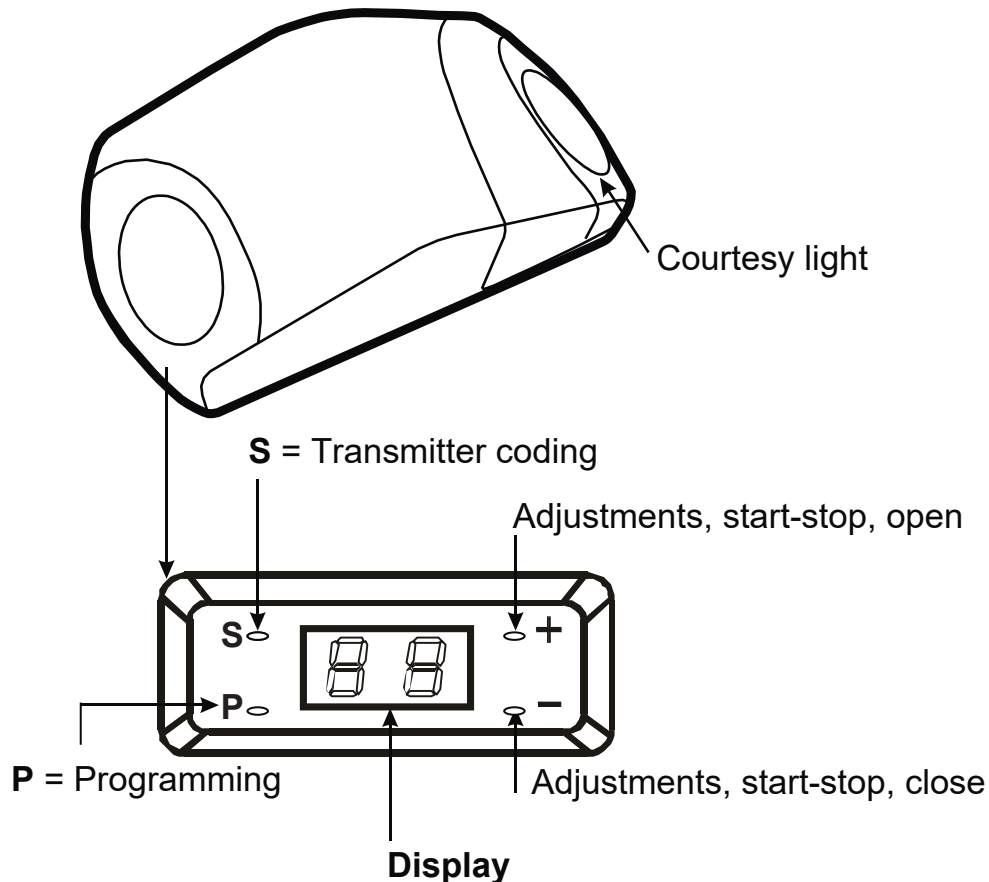

B1. MAIN FUNCTIONS

Door operation:	Give a start command using the transmitter. The courtesy light automatically goes on and goes off after 2.5 minutes .
Motor	Slowdown in opening and closing ensure maximum noiseless long lasting operation.
Self-diagnosis (see p.20)	The LED display allows full monitoring on operation and faults.
Alert system	If door remains opened, an alarm will sound within 10 minutes . The alarm stops when the door is closed (see p.10)
Power cut	In case of power failure the door can be manually released (see p.7)
Safety devices	Photocells, safety edges, key switches, emergency push buttons can be wired (see p.15)
Automatic closing	Automatic closing can be adjusted between 30 and 240 seconds.
Maintenance recall	After 2000 working cycles, an alert sound will be sent to remind the user maintenance is needed (see p.11)
Safety features	Obstacle detection in closing and opening (see p.9); safety devices inputs (p.15). If photocells or safety edges fail, the opener will automatically set to "dead man" mode.

B2. TECHNICAL FEATURES

	LIBRA	LIBRA PLUS
Main power supply	230V 50Hz	230V 50Hz
Motor thrust	100 W	150 W
Stand-by absorption	1,2 W	1,2 W
Motor power supply	24Vdc	24Vdc
Lift power	700 N	1100 N
Door dimensions	8m ² max	12m ² max
Door height	2,4m max	2,7m max
Rail length	3m	3,3m

B3. INTENDED USE AND DOOR FEATURES

LIBRA opener is intended for sectional doors application.

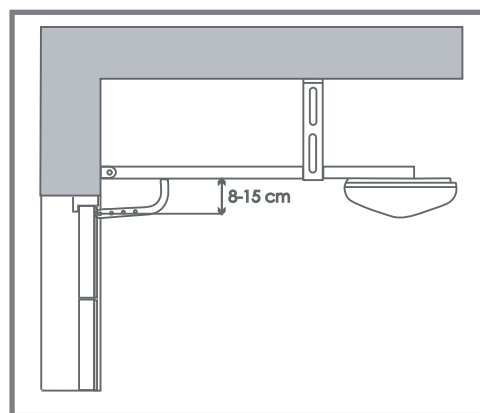
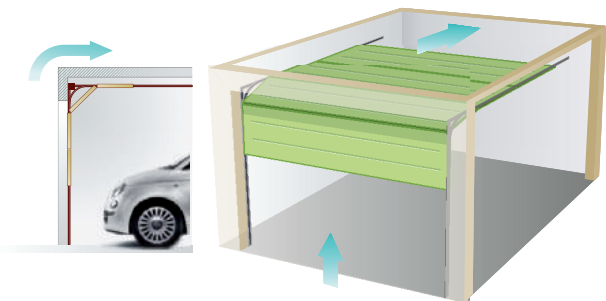

In case of counterweighted balanced doors, ARC adapter bracket is needed (available for sale accessory)

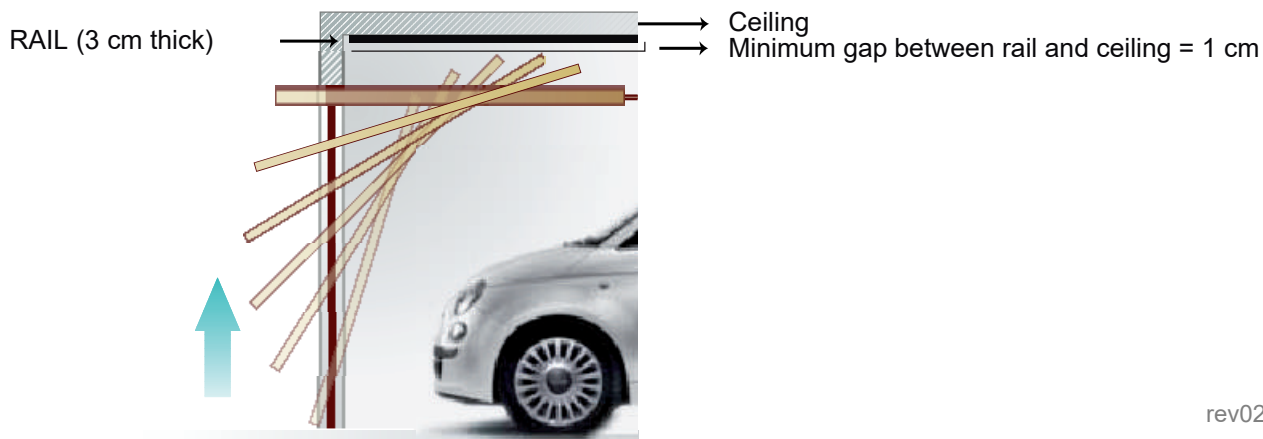
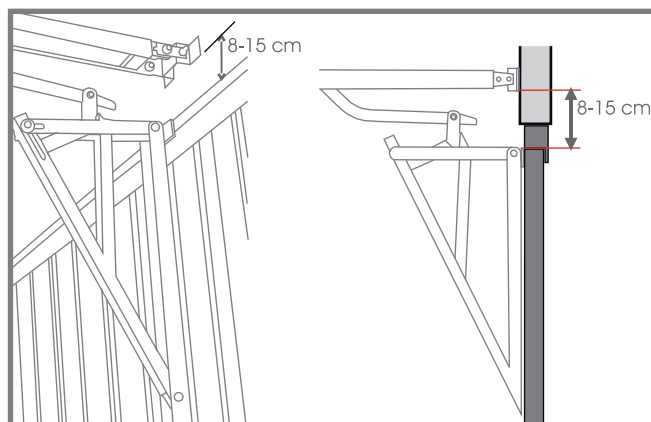
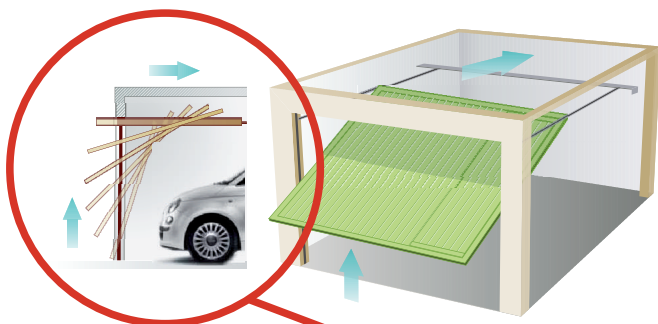

C. SAFETY TIPS AND PRELIMINARY CHECKS



**CAREFULLY FOLLOW MOUNTING INSTRUCTIONS.
AN IMPROPER INSTALLATION MAY CAUSE SEVERE INJURIES!**

- Before installing the automation, remove all unnecessary packaging and accessories;
- Check that door opens and closes easily and that mechanical parts are in good condition and correctly balanced;
- When installing make sure the manual release string is left less than 1,8 m length;
- Fixed start commands must be within the door area but safely far from moving parts, at minimum height of 1,5 m from ground.
- Visible permanent warnings of entrapment must be fitted.
- The emergency release system must be clearly permanently visible;
- Once installation is complete, make sure the opener is properly adjusted and reverses during closing if an obstacle is encountered at least 40 mm from ground;
- Make sure door does not obstruct public sidewalks or roads during operation;
- Once installation is completed, make sure the opener stops during opening if an obstacle is encountered. Put a 20 kg load in the centre of the door on the lower side to test the reaction of the system.

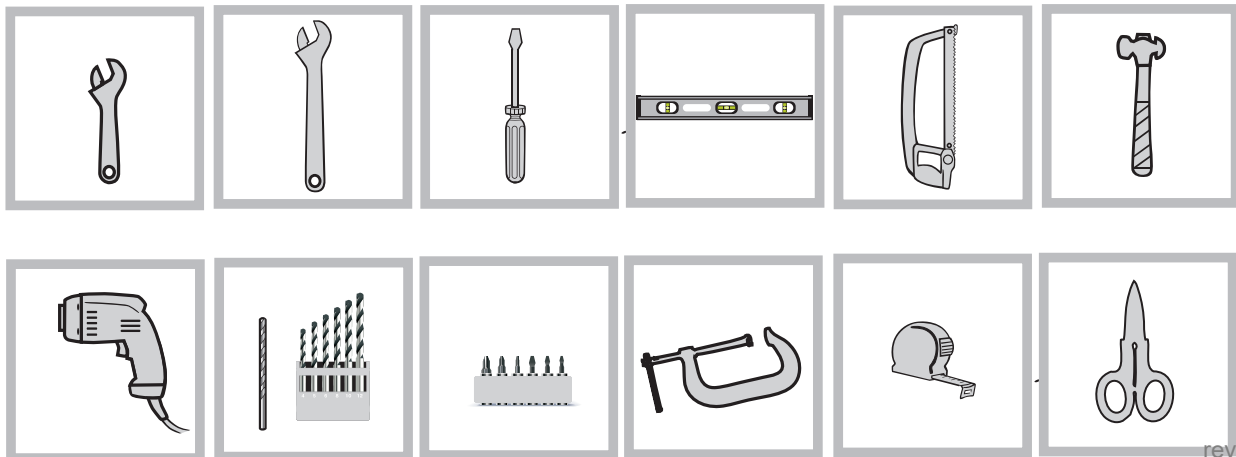

rev02_19

D. RAIL ASSEMBLY

- 1) Open the carton box



- 2) Lay the rail as shown below



- 3) Fit the joint keeping the two retainers at sight

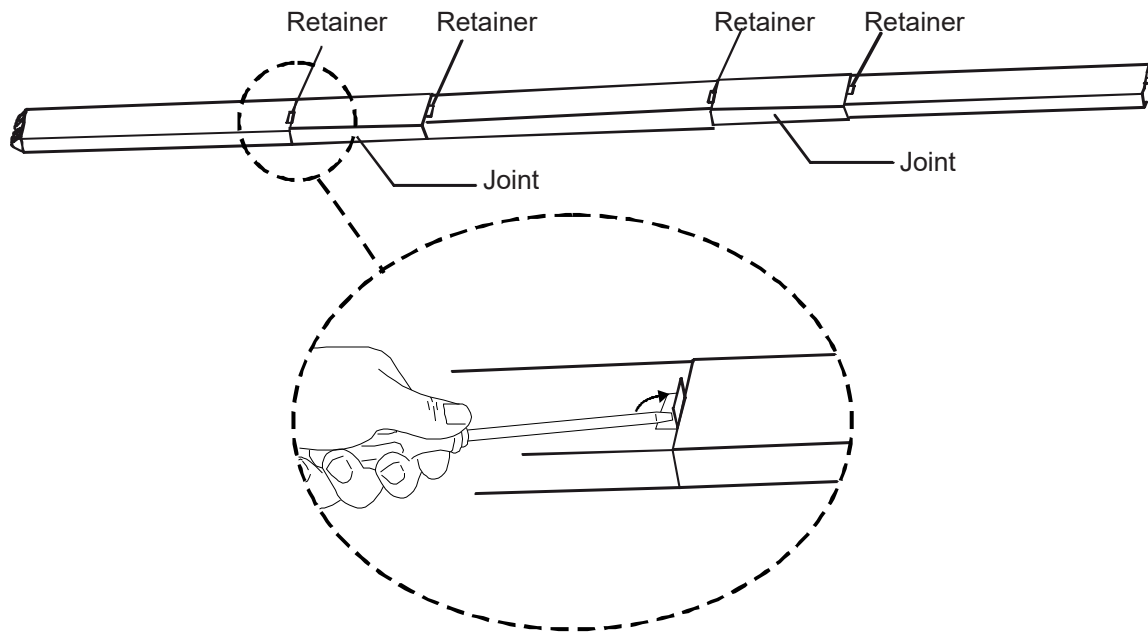

- 4) Use a 10 hex wrench to adjust the chain tension

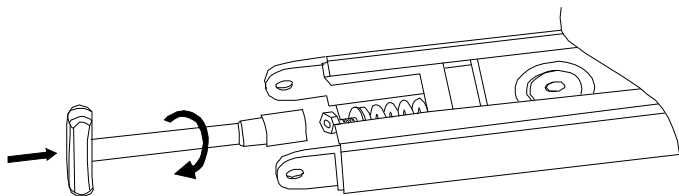

- 5) Adjust the distance as indicated

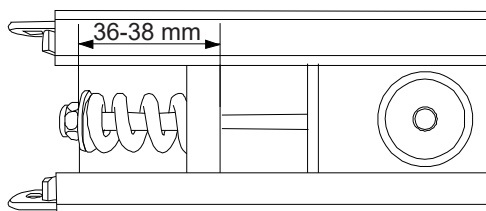

D1. GEARMOTOR AND RAIL MOUNTING

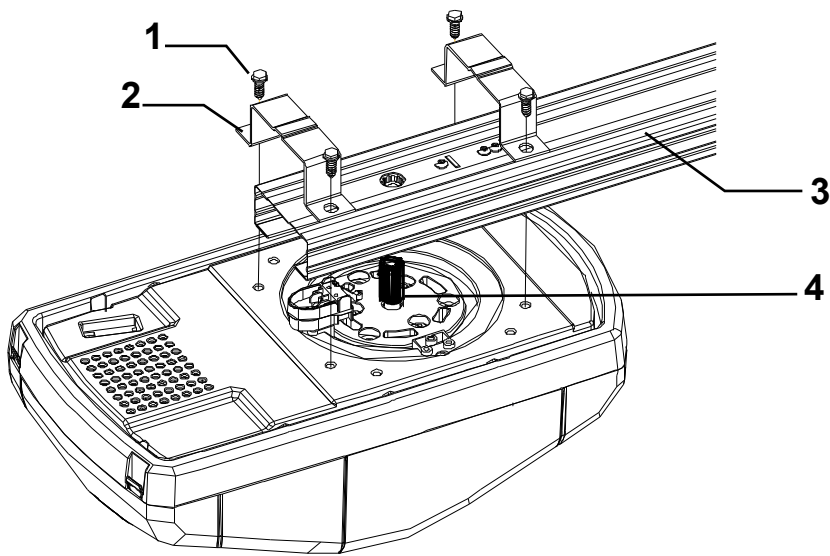

- 1 Self-tapping screws 6x15
- 2 Rail mounting bracket
- 3 Rail
- 4 Cogwheel

D2. GEARMOTOR AND RAIL FIXING

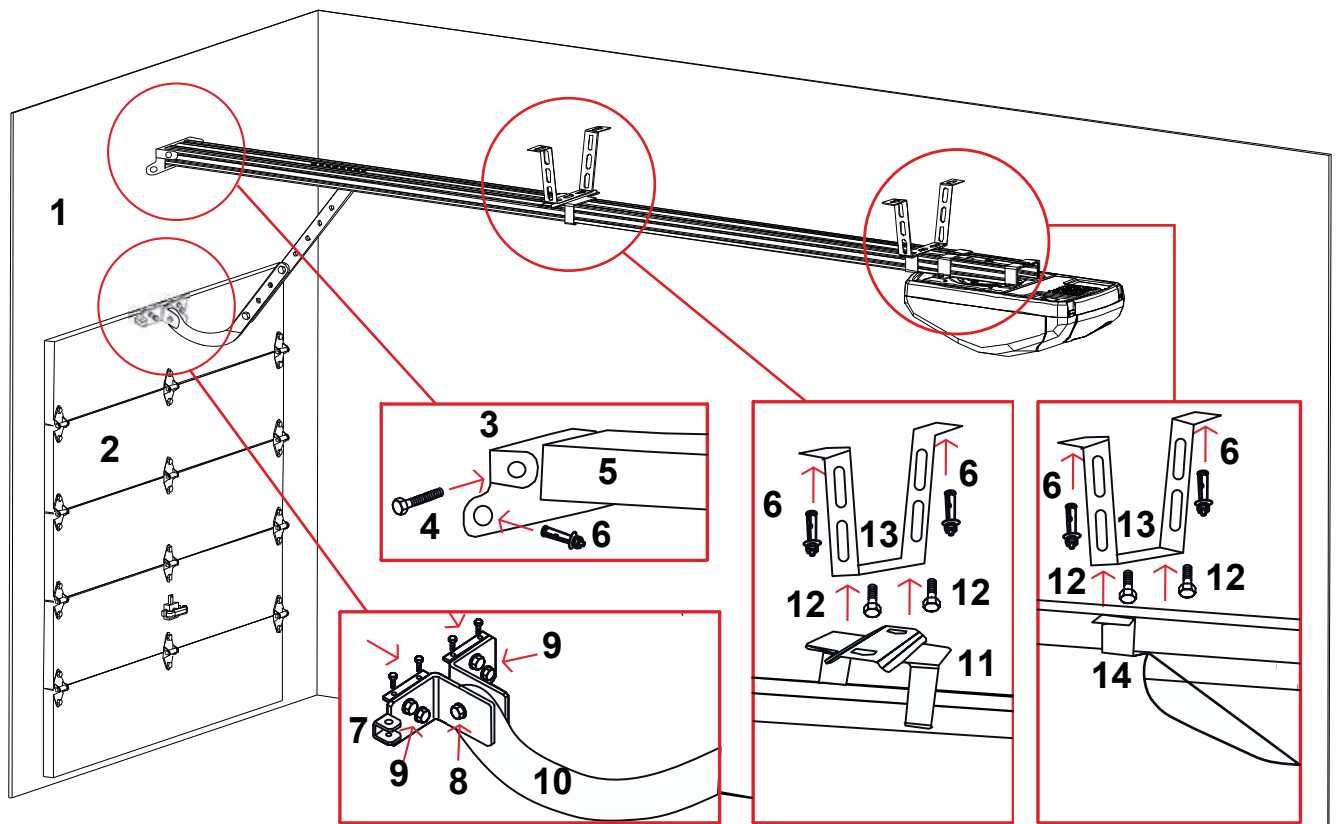

- 1 Wall
- 2 Door
- 3 Wall bracket
- 4 Screw 6x80
- 5 Rail
- 6 Screw anchor
- 7 Door fixing bracket
- 8 Hinge pin 8x25
- 9 Self-tapping screw 6x15
- 10 Bent arm
- 11 Support bracket
- 12 Screw 8x20
- 13 Gearmotor mounting bracket
- 14 Rail mounting bracket

rev02_19

D3. MANUAL OPENING

IF POWER FAILURE OCCURS:

- 1 When door is in **CLOSING POSITION**:
Pull the string and unlock the joint, so the door can easily lift.
- 2 When door is in **OPENING POSITION**:
Pull the string once to allow the door to close.

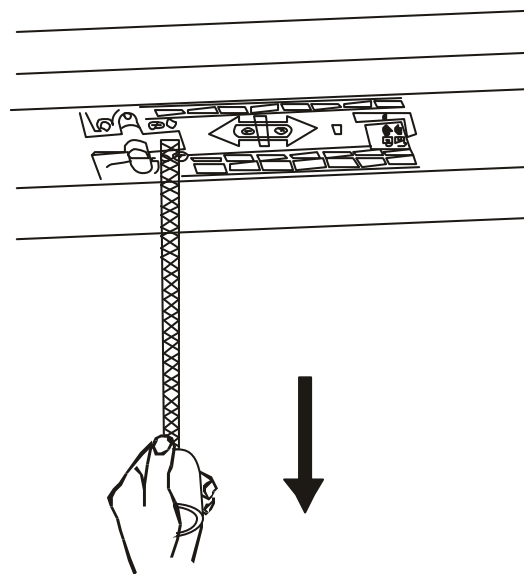
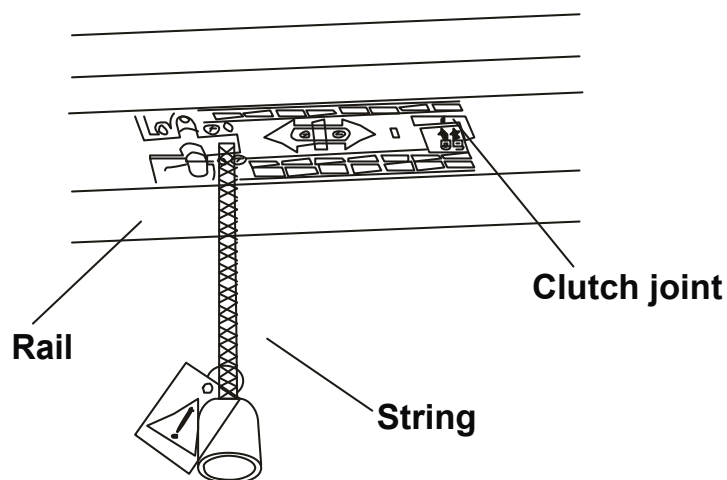

WHEN POWER RECOVERS

Give a start command using the transmitter or other fixed commands: the trolley clutch engages automatically.

D4. MANUAL RELEASE FROM OUTSIDE

If the garage has no pedestrian entry door, it's possible to fit an external release system to the existing garage door handle. The MLIR07 release kit can be purchased separately as an optional accessory (see page 16)

E. PROGRAMMING

Press "P" and hold for 8 seconds, to start programming. Once adjustments are done, press "P" and hold for 8 seconds again to save the settings and go out of the programming mode.

PRELIMINARY COMMISSIONING

- Lock the clutch and gently move the door to closing position.
- Power the garage door opener: the courtesy light **turns on**, the display shows a "0" rotating clockwise and the control unit **"beeps"** once.

E1. SETTING THE LIMIT SWITCH IN OPENING

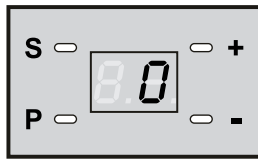

Press "P" and hold for 8 seconds

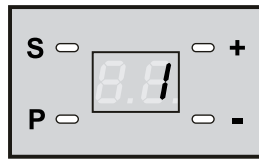

The control unit beeps and shows "1"

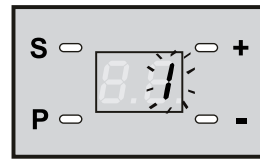

Press "P", "1" starts flashing

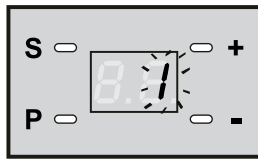

Press and hold "+"

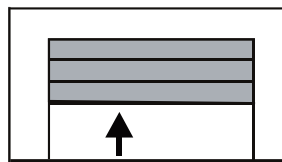

...until the door reaches the desired opening position

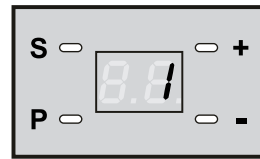

Press "P" to save

E2. SETTING THE LIMIT SWITCH IN CLOSING

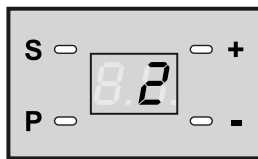

Press "+" to set "2"

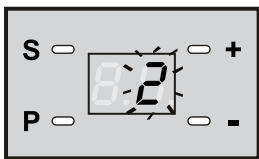
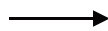

Press "P", "2" starts flashing

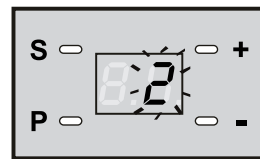

Press and hold "-"...

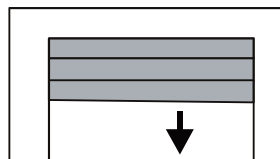
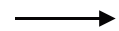

...until the door reaches the desired closing position

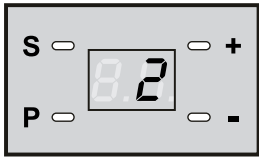
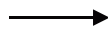

Press "P" to save

E3. FORCE

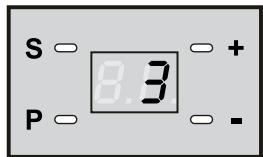

Press "+" to set "3"

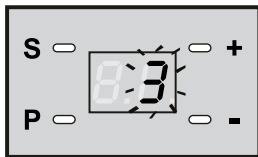

Press "P", "3" starts flashing

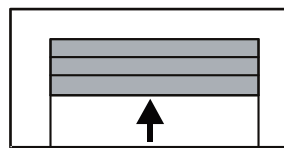

The door **opens** automatically

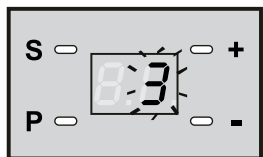

Press "P" when the door is in opening position. Press "P" again

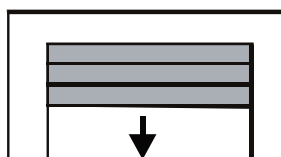

The door starts closing

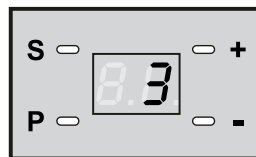

Press "P" to save

E4. OBSTACLE DETECTION

The factory value set is **3**, the end user should never change this setting.

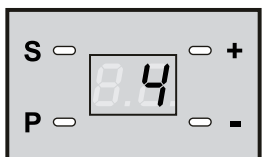

Press "+" to set "4"

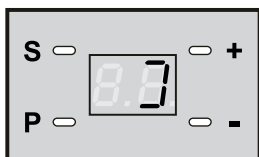

Press "P", then use "+" and "-" to increase or decrease the value

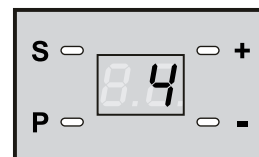
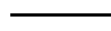

Press "P" to save

SENSITIVITY LEGEND:



= minimum

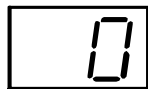

= maximum

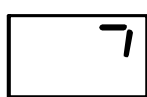
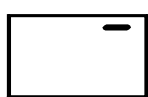

Factory value



A too high sensitivity can compromise normal operation: the door can stop and reverse before reaching the closing/opening position.

E5. OPENING SPEED

The factory value set is "2", setting "1" the opening speed slightly increases.

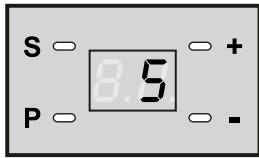

Press "+" to set "5"

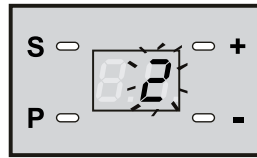

Press "P" and use "+" and "-" to change the value

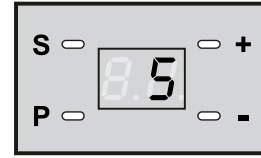

Press "P" to save

E6. DOOR OPENED ALERT

This function beeps within **10 minutes** if the door is left open. The factory setting is "0" (function deactivated); to activate it, set "1".

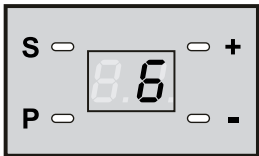

Press "+" or "-" to set "6"

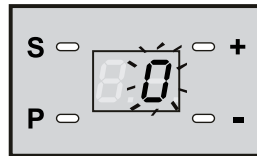

Press "P" and use "+" e "-" to activate or deactivate the function

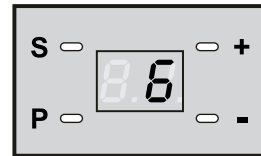

Press "P" to save

E7. AUTOMATIC CLOSING

It's possible to set the automatic closing (see the below time settings).
When the value is set to 0, the automatic closing is deactivated.

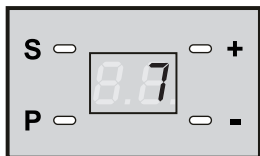

Press "+" or "-" to set "7"

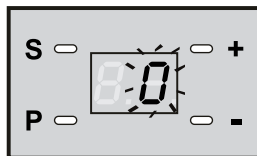

Press "P" and use "+" and "-" to change the value

Set up	Automatic closing time	Set up	Automatic closing time
0	Automatic closing OFF	5	2,5 minutes
1	30 seconds	6	3 minutes
2	60 seconds	7	3,5 minutes
3	90 seconds	8	4 minutes
4	2 minutes		

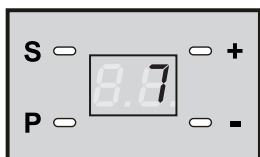

Press "P" to save

When automatic closing feature is set, an alarm sound will be sent all the waiting time long.

E8. 2000 CYCLES PERFORMED

This function allows to be alerted when 2000 cycles are performed. Set "1" if you wish to activate the function, set "0" if you wish to deactivate it (factory setting "0").

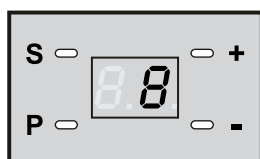

Press "+" or "-" to set "8"

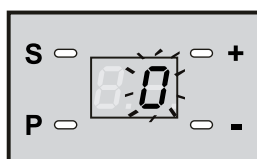

Press "P" and use "+" and "-" to activate or deactivate the function

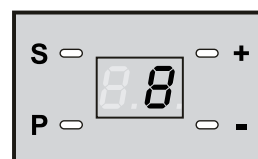

Press "P" to save

E9. MULTI-OCCUPATION SETTING

When the function is set to "0" (deactivated), giving a start command with the transmitter, the door will operate step by step: OPEN - STOP - CLOSE.

When the function is set to "1" (activated), giving a start command with the transmitter during OPENING, the door will disregard the command. During CLOSING, a start command will make the gate opening back.

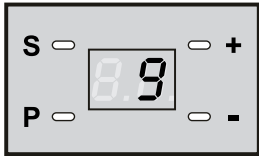

Press "+" or "-" to set "9"

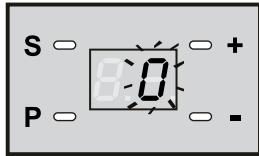

Press "P" and use "+" and "-" to activate or deactivate the function

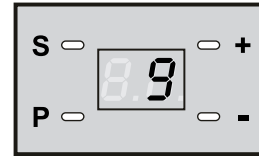

Press "P" to save

E10. TRANSMITTER SELECTION

Choose the transmitter type following the below procedure:

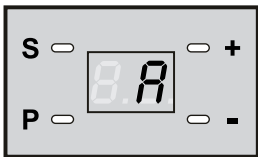

Press "+" or "-" to set "A"

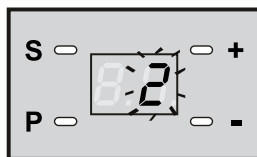
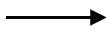

Press "P" and use "+" and "-" to change the transmitter

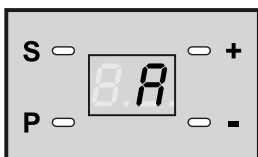
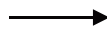

Press "P" to save

F. TRANSMITTER COMMISSIONING

F1. TRANSMITTER CODING

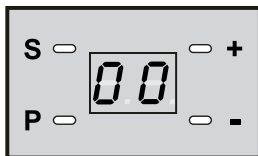

Press "S" once: the display shows a "0" on the left side.

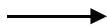

Press the key on the transmitter twice, before the "0" goes OFF. If storage succeeded, the opener will beep.



Now the transmitter has been successfully stored and giving a start command the door should move. Additional transmitters can be saved repeating the same procedure.

F2. TRANSMITTER DECODING

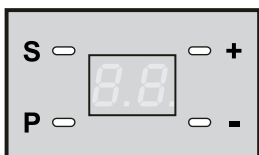

Press and hold "S" until display shows "0" on the left side

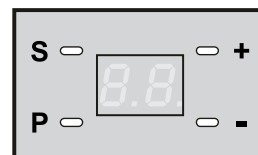
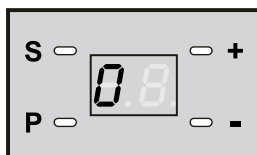

Hold "S" as long as "0" disappears

Now all transmitters previously saved have been duly deleted.



N.B.

For safety reasons we recommend to delete all transmitters if one of them is lost by accident.

WIRING DIAGRAM

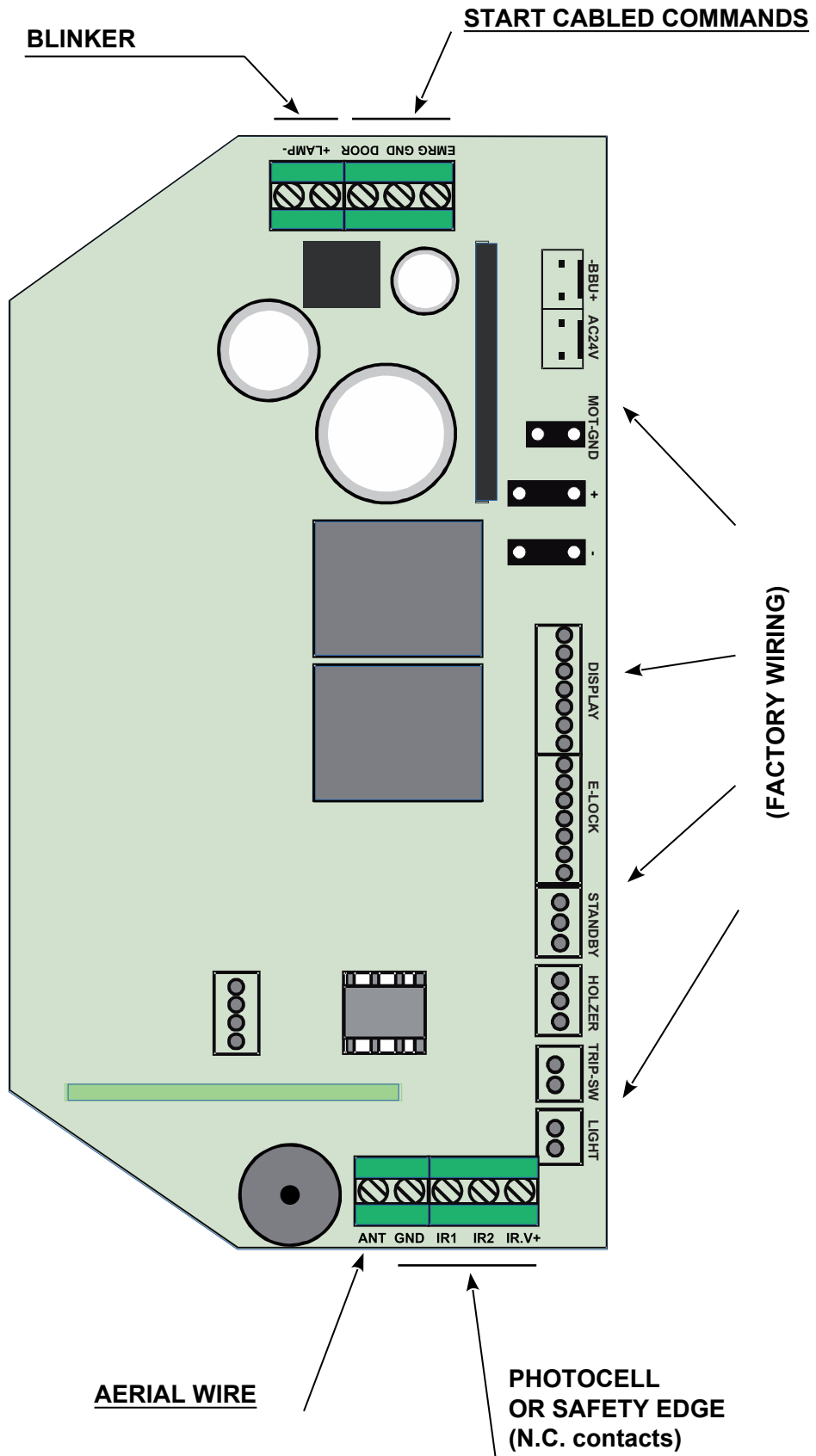

PHOTOCELL WIRING (Optional accessory)

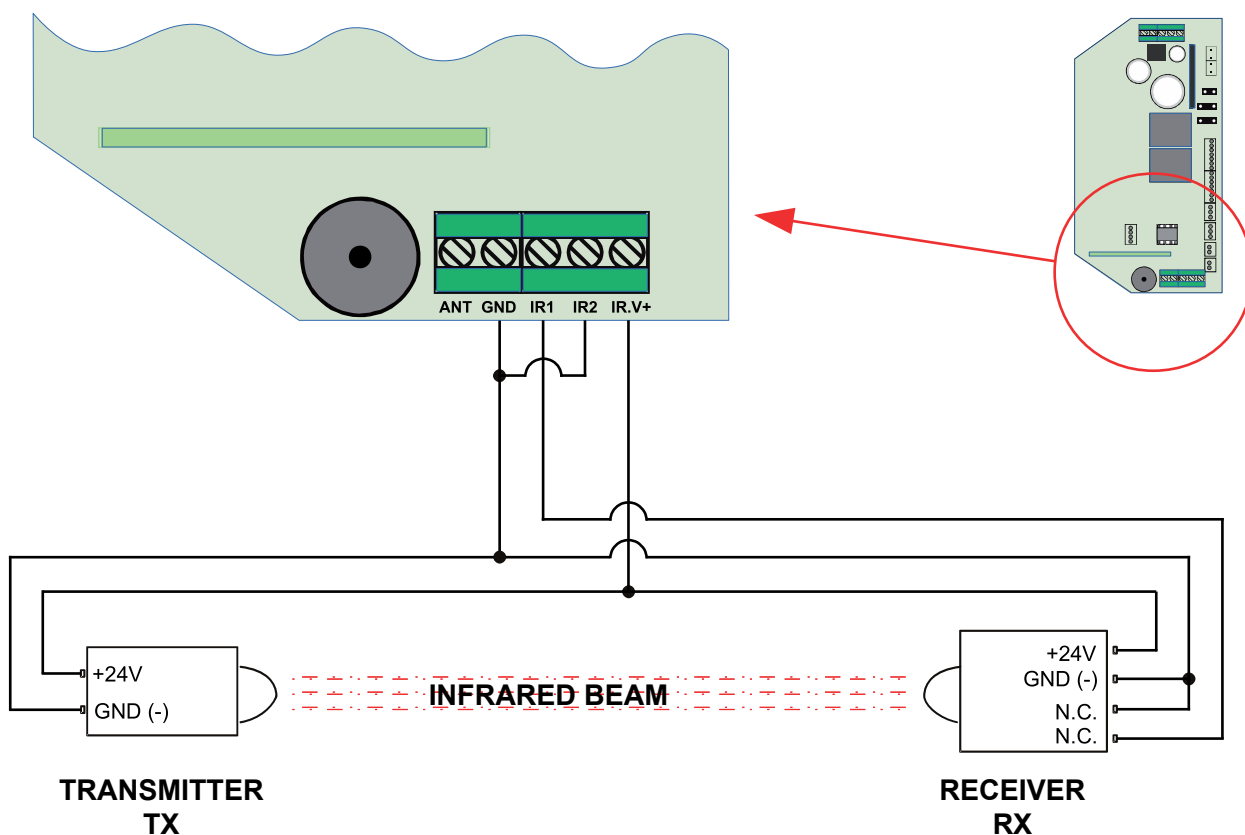

Photocells are 24 Vdc powered, terminal IR.V+.

IR1 and IR2 terminals are bridged with GND from factory; it's possible to wire up two photocell sets: in case of just one photocell set, only wire IR1, removing the bridge, as per the above diagram. Leave the bridge just on IR2.

IR1 and IR2 have to be wired to GND through NC contacts. Therefore bridge the RX NC contact to GND and wire the other NC contact to IR1 or IR2.

EMERGENCY PUSH BUTTON, START-STOP AND BLINKER contacts

It is possible to wire an emergency push button (N.C. contact), between EMRG and GND (remove the bridge).

It is possible to wire a push button (N.O. contact), between DOOR and GND; this button works exactly as a radio transmitter.

It is possible to wire a 24V blinker to terminals LAMP+ and LAMP-.

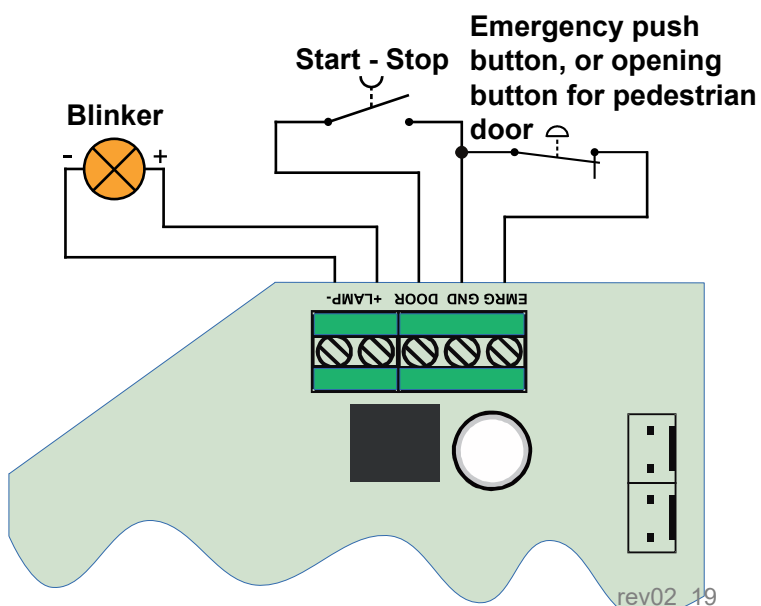

rev02_19

MANUAL RELEASE

SECTIONAL DOORS

- 1) Open the door fully.
- 2) Insert the inox cable inside the trolley (fig.A)
- 3) Insert the inox cable into the black membrane and pass it through the special slot on the door (fig.B)
- 4) Fix the inox cable to the lock release (fig.C1) or to the handle (fig.C2).
Make sure the cable is properly tightened so as to unlock when the handle is turned.
- 5) Cut the exceeding cable if necessary.



The manual release operation must always be performed when the automation is still.

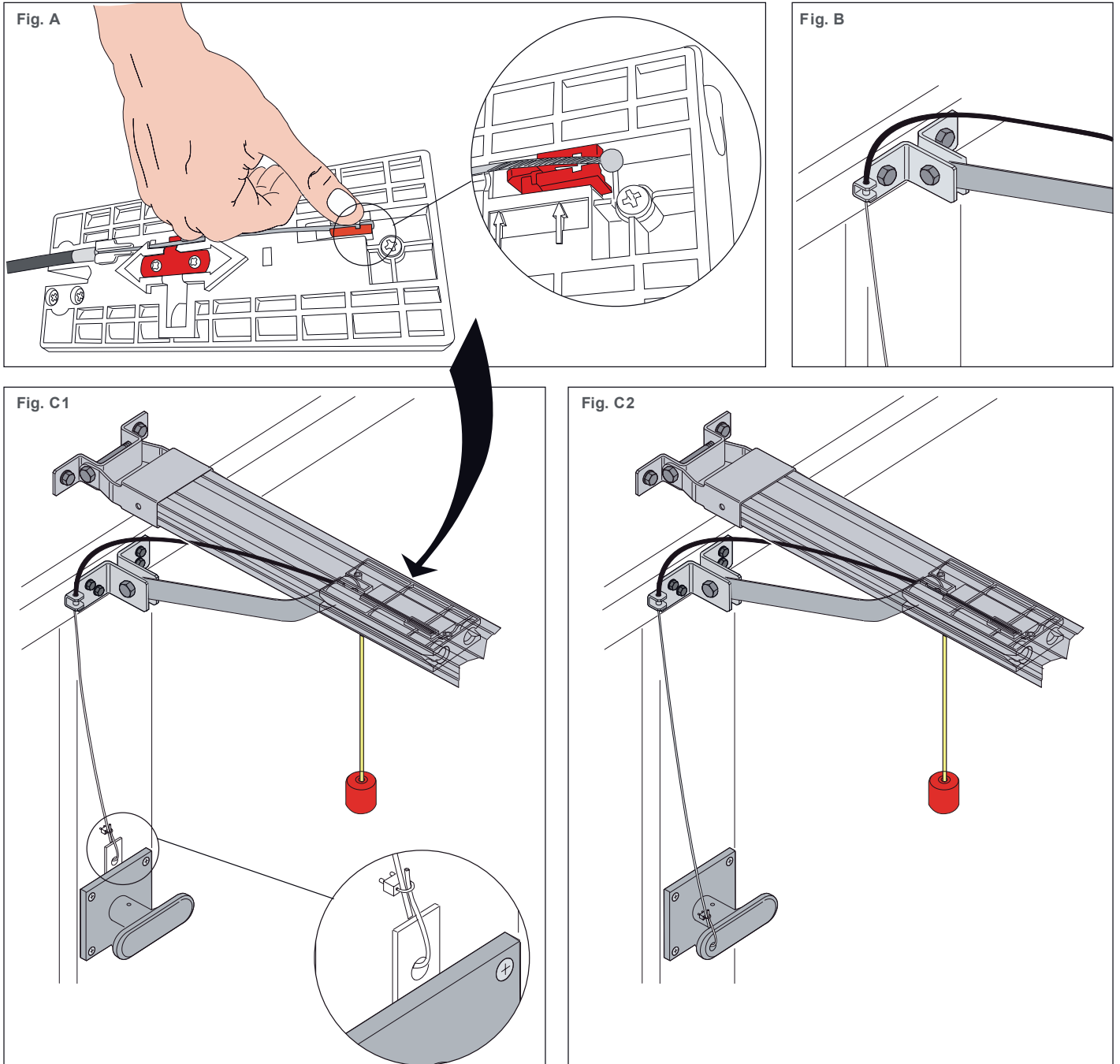

OVERHEAD DOORS (Adapter PARC01 available as optional)

- 1) Open the door fully.
- 2) Insert the inox cable inside the trolley (fig.A)
- 3) Cut the breaket (useless in case of overhead doors) as shown in fig. B and fix it on the door, beside the adapter. Insert the inox cable into the black membrane and pass it through the special slot on the door (fig.C)
- 4) Fix the inox cable to the lock release (fig.D1) or to the handle (fig.D2).
- 5) Make sure the cable is properly tightened so as to unlock when the handle is turned.
- 6) Cut the exceeding cable if necessary.



The manual release operation must always be performed when the automation is still.

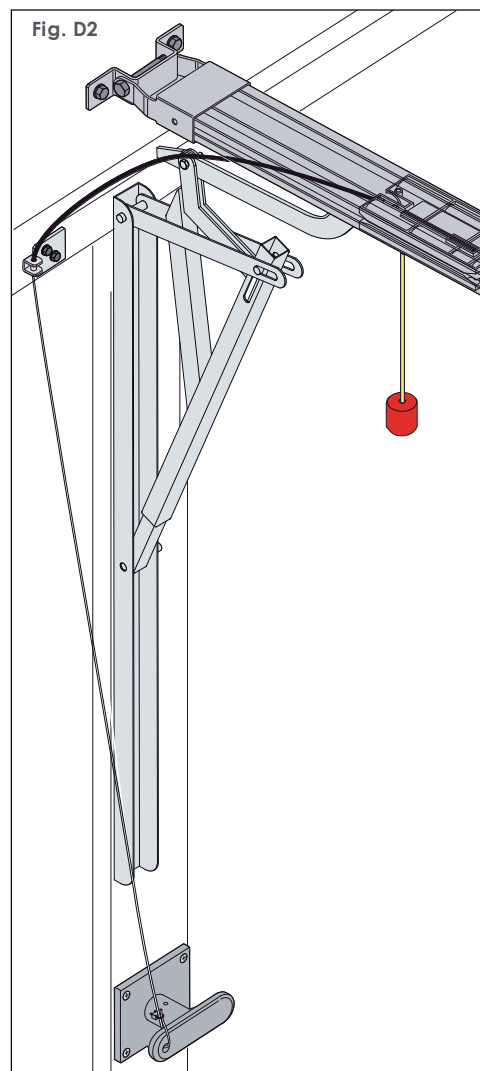
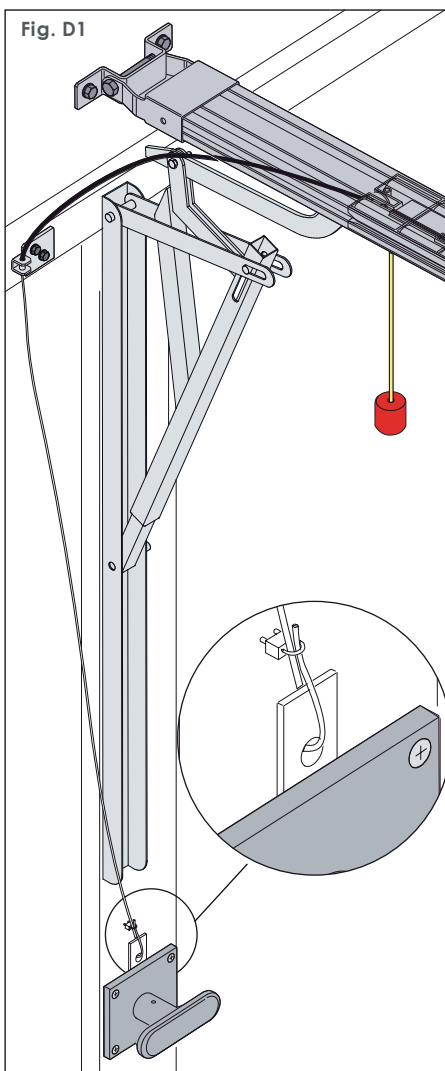
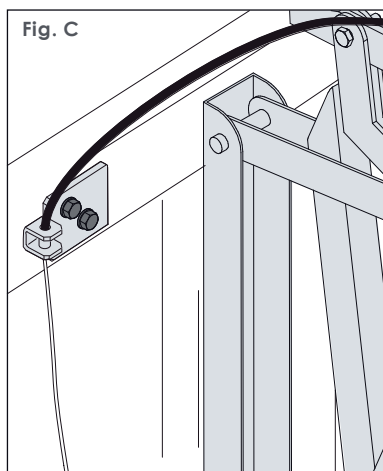
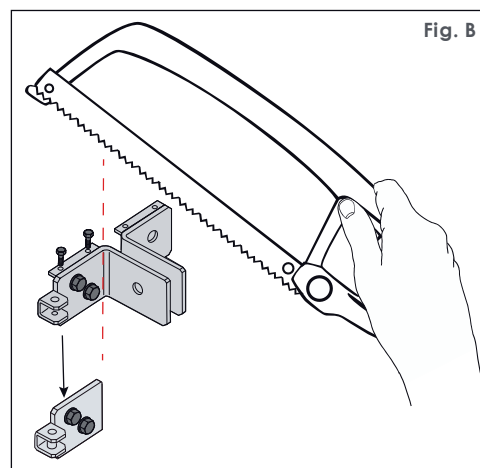
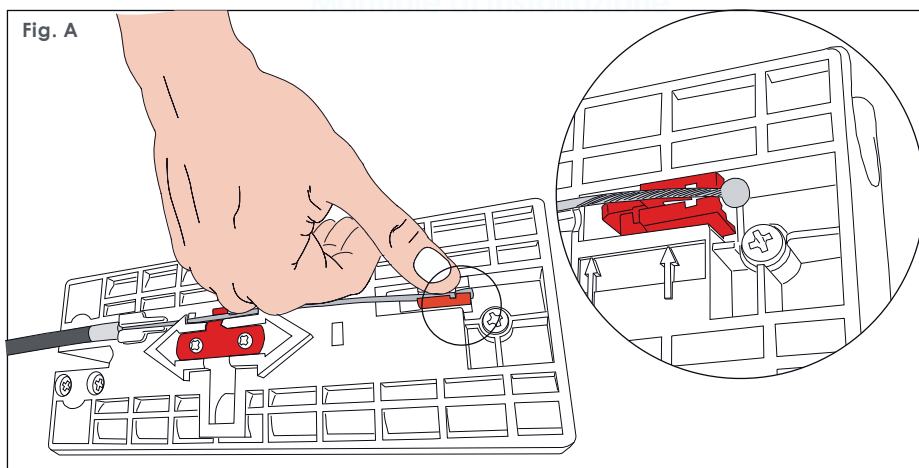

rev02_19

ARM ADAPTER FOR OVERHEAD GARAGE DOORS OPTIONAL ACCESSORY AVAILABLE FOR SALE

The ARC adapter arm is designed for counterweight spring overhead doors (fig.D) and looks like fig.E.

DRIVE ARM REPLACEMENT

- 1) Prepare the trolley for drive arm replacement (fig.F).
The drive arm is supplied with the automation LIBRA.
- 2) Unscrew the 5 screws that fix the trolley (fig.G).
- 3) The trolley when opened looks like fig.H. The drive arm is placed in the highlighted joint. To remove it, simply lift it from the seat. Make sure the
- 4) string for manual release is fitted inside the gap (fig.I)
- 5) Place the boomerang bracket provided with the arm adapter, leaving the string through as shown in fig.L
- 6) Tighten the 5 screws and fix the bracket to the trolley (fig.M)

ARC ADAPTER ARM MOUNTING

- 7) Fit the adapter arm to the boomerang bracket (fig.N)
- 8) Fix the adapter arm ARC in the center of the door, with the upper edge of the fixing plate at the height of the upper edge of the plate.
Fix the lower side of the fixing plate to the door frame (fig.O). Check the frame is strong enough, otherwise proper support must be provided.



Check the gap between the upper edge of the door and the rail of the automation is between 8 and 15 cm (fig.P)

- 9) Programm the door operator and check the correct operation of the system and the arm.

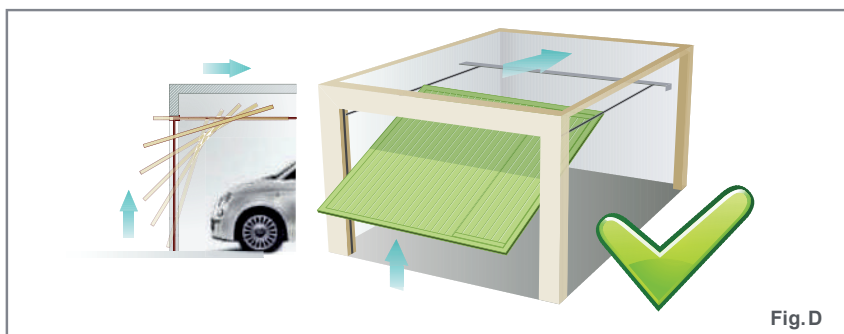

Fig.D

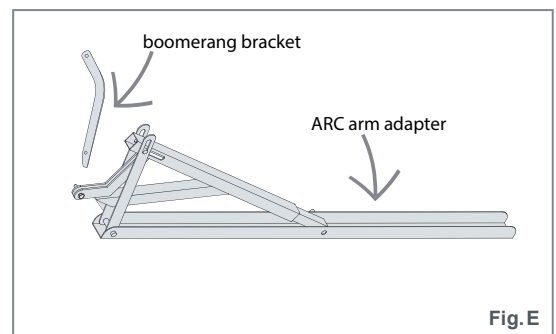

Fig.E

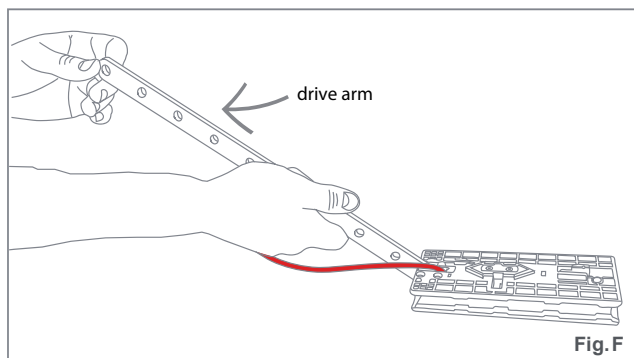

Fig.F

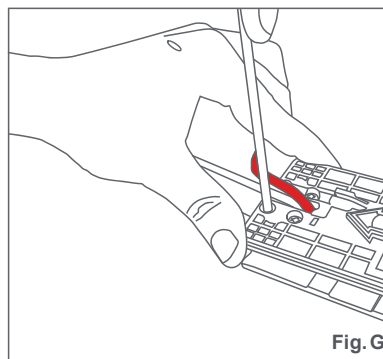

Fig.G

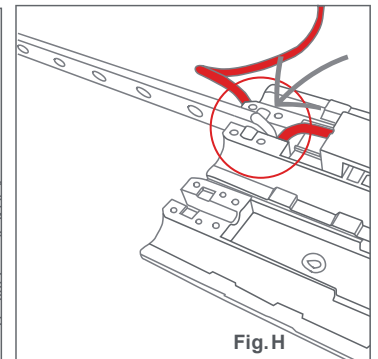

Fig.H

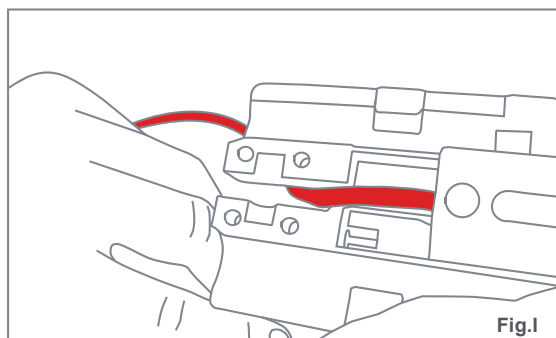

Fig.I

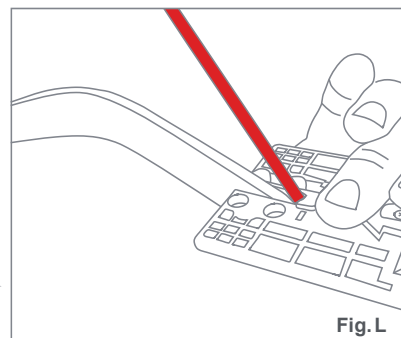

Fig.L

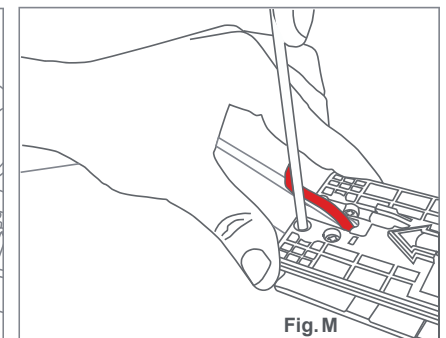
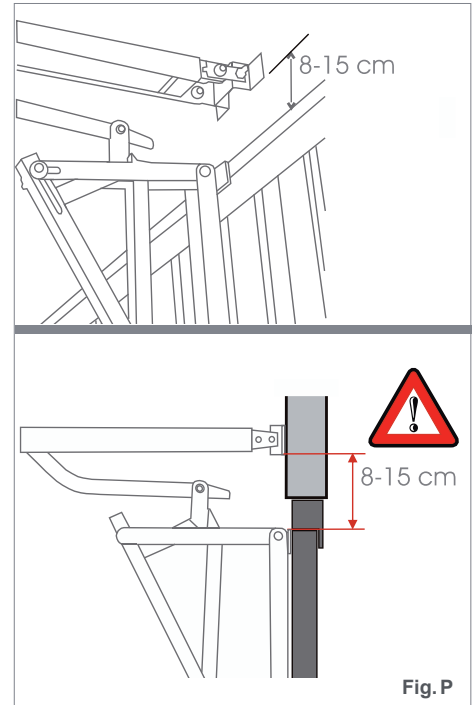
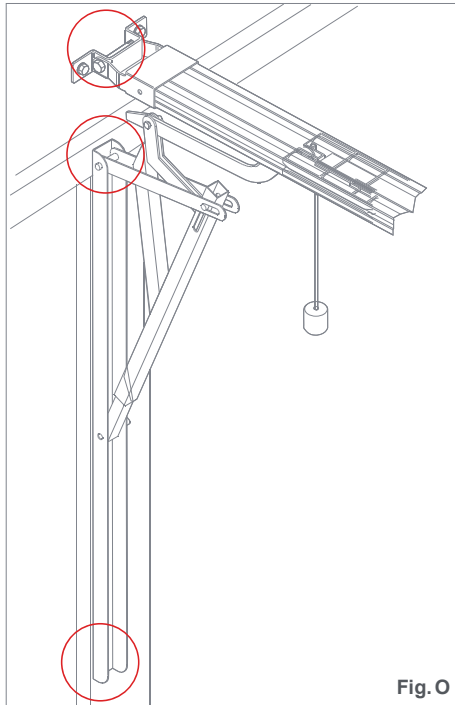
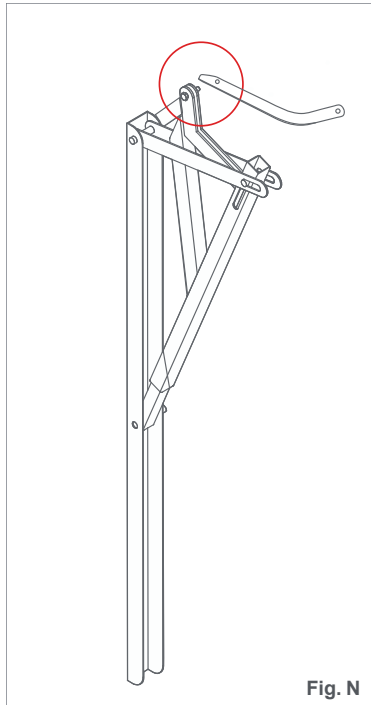

Fig.M



MAINTENANCE

- The LIBRA and LIBRA PLUS automation models for garage doors are low environmental impact products. Under normal use, just a minimal maintenance is required.
- Before starting the operation check that drive system slides fluently (unlock the trolley clutch, open and close the door manually).
- Periodically check that door opens and closes at the correct heights and that springs have sufficient thrust to lift the door. Lubricate mechanical gears regularly if necessary.

If power failure occurs the door will behave as follows:

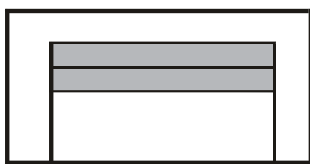

During blackout the door stops

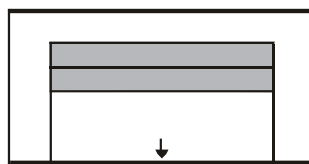

When power is restored, give a start command with the transmitter. The door starts closing.

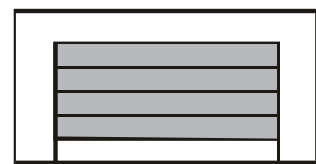

Reaches the limit switch in closing and stops.

In case of power cut, the door can be opened and closed manually, just unlocking the trolley clutch (pag.7).

TROUBLE SHOOTING

The control unit is integrated with self-diagnostic feature. Any possible faults will be detected and alerted through the display. Here below the list of most common faults and solutions.

Display	Fault	Cause	Solution
	THE AUTOMATION DOES NOT WORK, THE DISPLAY IS OFF	• Check the power supply.	Check the power supply.
		• Fuses can be possibly burnt.	Replace the fuses.
	THE DOOR DOES NOT MOVE	• No transmitter has been stored	Store a new remote control. Incorrect transmitter selection, review procedure.
		• Check the transmitter battery charge	Replace the battery.
	THE CHAIN TURNS BUT THE DOOR DOES NOT MOVE	• The trolley's clutch may be unlocked	Lock the clutch (p.7)
		• The chain has come out the cogwheel	Reposition the chain on the cogwheel.
	THE ALARM KEEPS ON SOUNDING	• The door is left opened since a while and the alarm function is activated	Close the door. Switch the power off and then on again.
		• 2000 cycles have been performed	
	THE DOOR DOES NOT OPEN NOR CLOSES, STUCKS WHEN CLOSING	• Unproper setting	Set limit switches again (p. 8).
		• Incorrect balancing of counterweights or springs	Adjust counterweights and springs.
		• Incorrect installation of the boomerang bracket (for overhead doors only)	Follow the installation instructions (p. 18)
H	THE DOOR DOES NOT WORK PROPERLY	<ul style="list-style-type: none"> • Possible humidity traces in the electronics and wires • Possible oxide traces in motor's wires • Photocell short circuit • Faultly microswitch 	Remove humidity (qualified personnel only) Check motor's wiring Check photocell's wiring (p.15) Check microswitch' wiring
A	THE DOOR DOES NOT MOVE OR DOES NOT COMPLETE THE CYCLE	• Incorrect photocell wiring	Check photocell operation and wiring again (p.15)
		• Permanent obstacle within the photocell area	Clear the photocell area.
L		• Microswitch operating - simple warning	
F	THE DOOR DOES NOT MOVE, OR STOPS, OR REVERSES	<ul style="list-style-type: none"> • Faulty door frame or incorrectly installed • Faulty motor or motor not wired • Faulty encoder or not wired 	Check the mechanical conditions of the door. Check the adjustment of springs and counterweights. Adjust the force settings, p.9 E3.
	THE DOOR STREAKS WHEN OPERATING	• Friction between rail and clutch due to waste	Properly lubricate the part between the rail and the clutch.
	THE CHAIN LOST TENSION AND IT'S NOISY	• Chain tension reduction due to extended use without regular lubrication	Fix the bolt properly on the spring, hold the chain in place and lubricate it.
		• The distance of the tension spring has not been adjusted	Follow the installation instructions (p. 5)
	THE DOOR REMAINS OPENED	• Incorrect photocell wiring	Check photocells wiring (p. 15)
		• Crushed safety microswitch	Check the safety microswitch is not crushed. Release the microswitch that may have been trapped.

EU DECLARATION OF CONFORMITY

The manufacturer: **PROTECO S.r.l.**

address: Via Neive, 77 – 12050 Castagnito (CN) – ITALIA

declares that

The product type: **LIBRA** garage door opener

models: **LIBRA, LIBRA Plus**

and accessories: **SK3000, SK3300, MYKEY/TX4334**

is built to be integrated into a machine or to be assembled with other machinery to create a machine under provisions of 2006/42/EC Machinery Directive.

It complies with the essential requirements of EU directives:

2014/30/UE (EMC)
2014/53/UE (RED)
RoHS2 2011/65/CE
2014/35/UE (LVD)

The product also complies, for the applicable parts, to the following directives and standards:

EN12453, EN12604
EN55014-1, EN55014-2, EN61000-6-1, EN61000-6-3
EN 60335-1, EN 60335-2-103, EN 60335-2-95

The manufacturer declares that the commissioning of the machinery is not permitted until the machine, which this product is incorporated into, has been identified and declared conformant to the 2006/42/EC Machinery directive.

Castagnito, May 27th 2019

Marco Gallo
Managing Director



This compliance declaration combines the content of separate compliance declarations for any product mentioned; a copy of the original compliance declaration of each product can be asked anytime to PROTECO Srl.

DISPOSAL



Do not dispose of in nature

Some components may contain hazardous waste.
They must, thus, be removed and turned into licensed firms for their disposal.
Before acting always check the local laws on the matter.



Proteco srl
Via Neive 77 12050 Castagnito
+39 0173 210132 www.proteco.net

rev02_19

